

sktp-19-04-2024 07_05_19-
21432

by 3 Perpustakaan UMSIDA

Submission date: 24-Apr-2024 08:09AM (UTC+0700)

Submission ID: 2359876947

File name: sktp-19-04-2024 07_05_19-214327.pdf (515.48K)

Word count: 4859

Character count: 27018

Home Surveillance Monitoring with Esp32-Cam and SD Card For Data Storage

Ivan Danu Tirta^{1*}, Arief Wisaksono², Akhmad Ahfas³, Jamaaluddin⁴

^{1,2,3,4}Prodi Teknik Elektro, Fakultas Sains dan Teknologi, Universitas Muhammadiyah Sidoarjo

¹Ivandanutirta3010@gmail.com, ²Ariefwisaksono@umsida.ac.id,

³Akhmadahfas@umsida.ac.id ⁴Jamaaluddin@umsida.ac.id

ABSTRACT

In the last three years the crime rate of theft has increased, to reduce crime this form of theft can be overcome by making a home security system using ESP32-CAM, the system made aims to conduct surveillance that can be seen again the results of images that have been taken by ESP32-CAM, then stored on the SD Card and send notifications to social media. This research uses the R&D (Research & Development) method or research, and development is a systematic study process to develop and validate products to be used in education. Products developed / produced include training materials for teachers, teaching materials, learning media, questions, and management systems in learning. The result of the implementation of a security system is the stage where the system that has been designed explains the creation of a system in accordance with previous analysis and design. After the implementation stage is carried out, a system test is needed to prove that the application can run properly. The test results that have been done using the android application and Sdcard run well, the PIR sensor can only detect objects as far as 4 meters. With this system, it is expected to be able to provide protection and security for homes, property, and residents. On the other hand, this approach also creates a chance to dig deeper into technology development using ESP32-CAM as an effective and efficient solution to tackle rising crime.

Keywords: Esp32-Cam Security System; Sd Card; PIR Sensor; Email; Surveillance and Notification Telegram

INTRODUCTION

Engaging in inappropriate behavior or making mistakes causes everyone to worry and feel anxious. This creates discomfort for others, especially homeowners who may often experience this when leaving home unattended. Ensuring the safety of their homes and belongings is crucial. Home security is very important for every home's family, we need a security device that can monitor the condition of the house at any time so that we know the condition of the house directly, various ways can protect the house from criminal activity by hiring a domestic assistant, but in this situation, hiring someone is very expensive (Setiawan et al. 2022).

Problems that are often found in the community, criminal acts such as motor vehicle theft are prone to occur due to negligence of supervision (Studi, Elektro, and Sidoarjo 2022). An example of the cause is that the house is easily entered by strangers because the house in a quiet and unsupervised state is very vulnerable to being infiltrated by criminals (Muhamad Satibi Mulya, Indra Yustiana 2022).

According to the 2021 Crime Statistics data, the number of theft crimes in the last three years (2018-2020) is quite high among other forms of crime. Along with the development of technology to reduce crime, this form of theft can be overcome by implementing a home surveillance monitoring system surroundings (Pitaloka, Ishak, and Halim 2021). By sending photos of environmental conditions around the house (Rifaini, Sintaro, and Surahman 2022), so that the surrounding environmental conditions can be maintained from crime. At the very least, the occupants of the house can easily identify the characteristics of criminal suspects using ESP32-CAM (M et al. 2023), (Wicaksono and Rahmatya 2020). To help with this problem, a home security system using ESP32-CAM was created, the system created aims to conduct surveillance that can be seen again the results of images that have been taken by ESP32-CAM and send notifications to social media (Asro Laili, Sumiati, and Triayudi 2022). And the cost is more affordable compared to hiring a domestic assistant.

* Corresponding author



This is an Creative Commons License This work is licensed under a Creative Commons Attribution-NonCommercial-ShareAlike 4.0 International (CC BY-NC-SA 4.0).

LITERATURE REVIEW

To support this research, it is necessary to have some theoretical foundations and some literature from previous research. Ahmad Hanafie (2022), which is about designing motion detection devices as security systems using IoT-based ESP32 - CAM. This research focuses on motion detection security systems with PIR sensors, FT232RL. In addition, it discusses system testing to measure hardware and software performance (Hanafie, Kamal, and Ramadhan 2022). DR. P.D Selvam (2022) discusses the utilization of ESP32 - CAM module in the development of intelligent visual surveillance systems. The system uses Wi-Fi technology and sensor devices to detect unauthorized objects and send notifications to users. The research elaborates on the importance of *embedded systems* embedded in everyday life and the transformation of surveillance systems from reactive actions to proactive actions [10]. A. Ipanhar (2002), presented the results of research on the design and implementation of automatic door monitoring systems based on *internet of things*. Using a *face recognition* system to access doors, this study aims to improve the quality of safety and comfort in the home area (Ipanhar, Wijaya, and Gunoto 2022). Devi Noviani (2021), With the title "Home security system using IoT-based Blynk", which can detect temperature, take pictures and send notifications using android smartphones and ESP32-CAM (Devi Noviani 2020). Yosi Rahmawati *et al* (2022), from Mercu Buana University made a warning system for zebra crossing violators at red lights using ESP32-CAM microcontrollers and HC-SR04 sensors. The system can detect motorists who cross the zebra crossing line, if anyone passes then the bell will be on as a warning, this aims to minimize traffic violations committed by motorists or cars in the hope of improving traffic compliance. However, the system still has limitations at night, the need for additional lighting so as not to wade through the quality of the captured image (Rahmawati, Simanjuntak, and Simorangkir 2022).

METHOD

Overall, the purpose of this study is to produce a product, namely home surveillance monitoring with Esp32-Cam and SD Card for data storage. Based on the objectives mentioned in Chapter 1, the appropriate method to use is the research and development method or better known as R&D (*Research & Development*). The reason behind choosing a research and development strategy is based on Sugiyono's opinion that research and development methods have been widely used in the fields of Natural Sciences and Engineering (Sugiyono 2013). Products developed/produced include training materials for teachers, teaching materials, learning media, questions, and management systems in learning. Asro Laili, Mohamad, Sumiati, and Agung Triayudi. 2022. "Pendekatan Nodemcu Dan Apps Blynk Berbasis Android Untuk Sistem Monitoring Keamanan Kendaraan Motor." *JSiI (Jurnal Sistem Informasi)* 9(2):119–25. doi: 10.30656/jsii.v9i2.5161. ³

Desmira, Desmira, Didik Aribowo, Widhi Dwi Nugroho, and Sutarti Sutarti. 2020. "Penerapan Sensor Passive Infrared (PIR) Pada Pintu Otomatis Di Pt LG Electronic Indonesia." *PROSISKO: Jurnal Pengembangan Riset Dan Observasi Sistem Komputer* 7(1). doi: 10.30656/prosisko.v7i1.2123.

Devi Noviani, Slamet Riyanto. 2020. "Aplikasi Sistem Keamanan Rumah Berbasis Internet of Things Menggunakan Blynk." *Seminar Nasional Teknologi Informasi dan Komunikasi-2021* 4:405–15.

Hanafie, Ahmad, Kamal, and Rahmat Ramadhan. 2022. "Perancangan Alat Pendeteksi Gerak Sebagai Sistem Keamanan Menggunakan ESP32 CAM Berbasis IoT." *Jurnal Teknologi Dan Komputer (JTEK)* 2(02):142–48. doi: 10.56923/jtek.v2i02.101.

Ipanhar, A., Toni Kusuma Wijaya, and Pamor Gunoto. 2022. "Perancangan Sistem Monitoring Pintu Otomatis Berbasis Iot Menggunakan Esp32-Cam." *Sigma Teknika* 5(2):333–50. doi: 10.33373/sigmateknika.v5i2.4590.

Joan, Joan, Zulfian Azmi, and Ardianto Pranata. 2022. "Implementasi Iot (Internet Of Things) Untuk Spy Jacket Dengan Berbasis Esp32-Cam." *Jurnal Sistem Komputer Triguna Dharma (JURSIK TGD)* 1(4):142. doi: 10.53513/jursik.v1i4.5591. ³

M, Ardiansyah, Aldi Febryan, Andriani, and Rahmania. 2023. "Rancang Bangun Sistem Keamanan Rumah Berbasis Telegram Menggunakan Esp 32 Cam." *Jurnal Teknik Elektro UNIMUH* 15(1):64–71. doi: <https://doi.org/10.26618/jte.v15i1.10246>.

Muhamad Satibi Mulya, Indra Yustiana, Ivana Lucia Khrisma. 2022. "Jurnal Computer Science and Information Technology (CoSciTech)." 3(3):371–81. doi: <https://doi.org/10.53513/jursik.v1i1.4795>. ³

Nur Atikah, Tuti Hartati, Agus Bahtiar, Kaslani, and Odi Nurdiawan. 2022. "Sistem Image Capturing Menggunakan ESP32-Cam Untuk Memonitoring Objek Melalui Telegram." *KOPERTIP : Jurnal Ilmiah Manajemen Informatika Dan Komputer* 6(2):49–53. doi: 10.32485/kopertip.v6i2.141.

Pitaloka, Pera, Ishak, and Jufri Halim. 2021. "Implementasi Internet of Things (IOT) Pada Sistem Monitoring Rumah Dengan Esp Cam Berbasis Mikrokontroler." *Jurnal CyberTech* 4(1):1–9.

Rahmawati, Yosy, Imelda Uli Vistalina Simanjuntak, and Rianka Bayu Simorangkir. 2022. "Rancang Bangun

* Corresponding author



This is an Creative Commons License This work is licensed under a Creative Commons Attribution-NonCommercial-ShareAlike 4.0 International (CC BY-NC-SA 4.0).

- Purwarupa Sistem Peringatan Pengendara Pelanggar Zebra Cross Berbasis Mikrokontroler ESP-32 CAM." *Jambura Journal of Electrical and Electronics Engineering* 4(2):189–95. doi: 10.37905/jjee.v4i2.14499.
- Ramschie, A., J. Makal, and R. Katuuk. 2021. "Pemanfaatan ESP32 Pada Sistem Keamanan Rumah Tinggal Berbasis IoT." *Workshop and National* 4–5.
- Rifaini, Arinda, Sanriomi Sintaro, and Ade Surahman. 2022. "Alat Perangkap Dan Kamera Pengawas Dengan Menggunakan Esp32-Cam Sebagai Sistem Keamanan Kandang Ayam." *Jurnal Teknik Dan Sistem Komputer* 2(2):52–63. doi: 10.33365/jtikom.v2i2.1486.
- Selvam, Dr P. D., K. Nikhil, K. Ranjitha Reddy, A. Mounika, P. Reddy Sekhar, M. Reddy, and Siva Sai. 2022. "Surveillance Monitoring Using Esp32-Cam Module." *International Journal of Creative Research Thoughts* 10(4):660–65.
- Setiawan, Andi, and Ade Irma Purnamasari. 2019. "Pengembangan Passive Infrared Sensor (PIR) HC-SR501 Dengan Microcontrollers ESP32-CAM Berbasis Internet of Things (IoT) Dan Smart Home Sebagai Deteksi Gerak Untuk Keamanan Perumahan." *Prosiding Seminar Nasional SISFOTEK (Sistem Informasi Dan Teknologi Informasi)* 3(1):148–54.
- Setiawan, Dedi, Hendra Jaya, Saiful Nurarif, Trinanda Syahputra, and Muhammad Syahril. 2022. "Implementasi Esp32-Cam Dan Blynk Pada Wifi Door Lock System Menggunakanteknik Duplex." *Journal of Science and Social Research* 5(1):159. doi: 10.54314/jssr.v5i1.807.
- Studi, Program, Teknik Elektro, and Universitas Muhammadiyah Sidoarjo. 2022. "Sistem Camera Dan Pengamanan Kotak Amal Berbasis Internet Of Things Dan Telegram." *SinarFe7* 5(1):44–48.
- Sugiyono. 2013. *Metode Penelitian Kuantitatif, Kualitatif, Dan R&D*. Bandung: Alfabeta.
- Susana, Ratna, Muhammad Ichwan, and Saverio Al Phard. 2018. "Penerapan Metoda Serial Peripheral Interface (SPI) Pada Rancang Bangun Data Logger Berbasis SD Card." *ELKOMIKA: Jurnal Teknik Energi Elektrik, Teknik Telekomunikasi, & Teknik Elektronika* 4(2):208. doi: 10.26760/elkomika.v4i2.208.
- Wicaksono, Mochamad Fajar, and Myrna Dwi Rahmatya. 2020. "Implementasi Arduino Dan ESP32 CAM Untuk Smart Home." *Jurnal Teknologi Dan Informasi* 10(1):40–51. doi: 10.34010/jati.v10i1.2836.
- Wisaksono, Arief, and Muhammad Umar Mokhtar. 2022. "Kontrol Lampu Otomatis Dengan Sistem Hybrid." *Cakrawala Ilmiah* 1(10):2359–66.

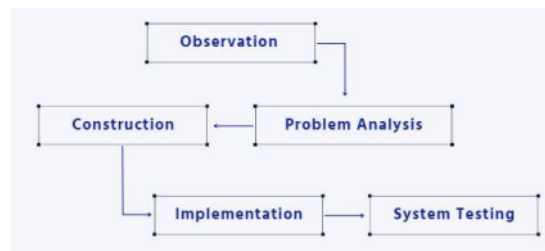

Figure 1. Work Steps
Source: Researcher Property

Stages of Research

To carry out research to achieve maximum results related to research and system design, it is necessary to carry out several work steps, namely:

- a. Observation: Surveillance monitoring experiments with Esp32-Cam and sdcard as data storage by observing previous phenomena such as increased crime. Then determine the solution to solve the problem by creating an automatic surveillance monitoring tool.
- b. Problem Analysis: This analysis is carried out on the problem that needs to be solved, namely how to reduce crime. The problem is how to maximize the use of Esp32-Cam for monitoring and surveillance of a house.
- c. Construction Design:
 - a) Hardware Design

This tool is designed with holes on the sides that function as antennas for sending and receiving signals. The top hole is intended for cables connected to solar panels, which supply power to the device. At the

* Corresponding author



This is an Creative Commons License This work is licensed under a Creative Commons Attribution-NonCommercial-ShareAlike 4.0 International (CC BY-NC-SA 4.0).

front end is a PIR sensor designed to detect motion. Voltmeter menampilkan tingkat pasokan baterai device. Lastly, ESP32-CAM cameras are used to take pictures, usually applied for security or IoT purposes.

b) Software Design

This is the program code for Esp32-Cam combined with hardware that has been designed to work as desired.

d. Implementation

The Esp32-Cam device will be implemented in the home area. This device is a sophisticated microcontroller integrated with Wi-Fi and Bluetooth connections and cameras. This device will be used for surveillance monitoring purposes in the environment around the house. The device can be programmed with Arduino IDE software to send alerts and notifications to the user's smartphone if there is suspicious activity.

e. System Testing

System testing is the stage where the system is in accordance with what is desired. It contains explanations related to what is being studied.

System Planning

Blok Diagram

In this block diagram of the system displays the system to be created.

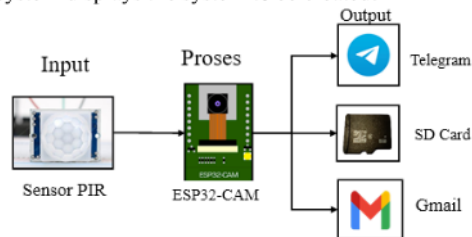

Figure 2. Block Circuit Diagram

Source: Researcher Property

Based on Figure 2 Data retrieval taken from the sensor will be transmitted to the microcontroller for data processing. From the processing will be stored on the SD Card. The programming of this system uses *Arduino IDE software*.

1. Passive Infrared *sensor* as detects temperature changes caused by the movement of surrounding objects based on the emission of infrared rays emitted through Fresnel lenses, infrared radiation emits heat energy (Desmira et al. 2020). After that, the signal is amplified using the comparator as a 1-bit signal. As a result, the PIR sensor outputs only logic 1 or 0 [(Setiawan and Irma Purnamasari 2019)(Wisaksono and Mokhtar 2022).
2. ESP32-CAM as a microcontroller that functions to process and control center and process data and embedded programs (Ramschie, Makal, and Katuuk 2021). And the sd card as a medium for storing photo data so that users can see the data after the previous incident (Joan, Azmi, and Pranata 2022).
3. As well as incorporating the Gmail app to receive photos on android, this setting allows real-time monitoring and recording of events within range of the camera. The captured images can then be easily accessed and reviewed via the Gmail app on Android devices (Nur Atikah et al. 2022).
4. By adding a notification via the telegram application that the photo has been stored on the SD Card and sent via email with this it is ensured that the photo has been stored safely and shared with the intended recipient. This Telegram application feature makes it easy for users to get notifications (Susana, Ichwan, and Phard 2018).

* Corresponding author



This is an Creative Commons License This work is licensed under a Creative Commons Attribution-NonCommercial-ShareAlike 4.0 International (CC BY-NC-SA 4.0).

Tool Connection Design

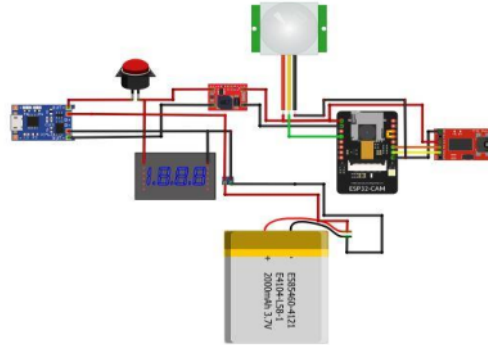

Figure 3. Tool Connection

Source: Researcher Property

Figure 3 shows the whole set of tools that I will use as follows:

The system works by activating the built-in motion sensor to detect motion, it becomes active and sends a signal to the ESP32-CAM. Then, the ESP32-CAM starts the process of taking photos and saving them to the microSD card available in the device.

Finished Tool Design



Gambar 4. Desain Hardware

Source: Researcher Property

Based on Figure 4 In making this design aims to minimize errors, with good planning is expected to be able to produce quality tools that are reliable. Tool size 10cm x 7.5cm x 3.5cm. with an adjusted size. This tool is designed with holes on the sides that function as antennas for sending and receiving signals. At the front end is a PIR sensor designed to detect motion. The voltmeter displays the battery supply level of the device.

System Flowchart

* Corresponding author



This is an Creative Commons License This work is licensed under a Creative Commons Attribution-NonCommercial-ShareAlike 4.0 International (CC BY-NC-SA 4.0).

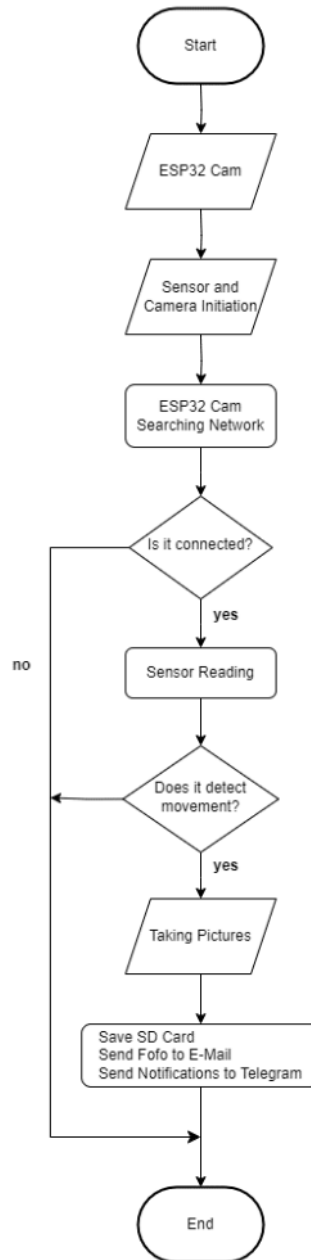

Figure 5. Flowchart

4. RESULT

The result of the implementation of a security system is the stage where the system that has been designed, explains the creation of a system in accordance with previous analysis and design. After the implementation stage is carried out, a system test is needed to prove that the application can run as expected. Home surveillance systems have

* Corresponding author



This is an Creative Commons License This work is licensed under a Creative Commons Attribution-NonCommercial-ShareAlike 4.0 International (CC BY-NC-SA 4.0).

been carefully designed and developed to meet their intended purpose. The hardware configuration can be seen in the attached image.

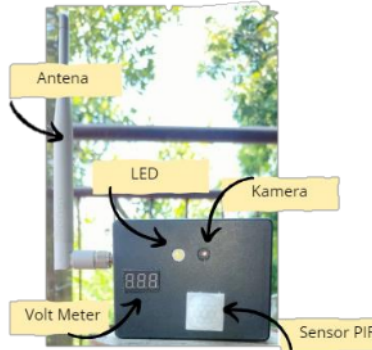

Figure 6. Results of Home Surveillance System Tools

Source: Researcher Property

Figure 10 is the final view of the shape of the tool after all components are designed and assembled beforehand, thus forming a tool that can monitor home surveillance with Esp32-Cam and sd card as data storage.

Test Results on Android

The result of the implementation of a security system is the stage where the system that has been designed, explains the creation of a system in accordance with previous analysis and design. After the implementation stage is carried out, a system test is needed to prove that the application can run as expected.

a. SD Card Display



Figure 7. Storage Display on SD Card

Source: Researcher Property

Based on figure 7 is the result of the display of images that have been stored on the sd card. There is a difference in the resulting bright and blurry images influenced by lighting condition factors that also affect the results of the image captured by ESP32-CAM. In good lighting conditions, the resulting image will be brighter and clearer. Conversely, in poor lighting conditions, the resulting image will be darker and blurry.

* Corresponding author



This is an Creative Commons License This work is licensed under a Creative Commons Attribution-NonCommercial-ShareAlike 4.0 International (CC BY-NC-SA 4.0).

b. Display notifications in Telegram

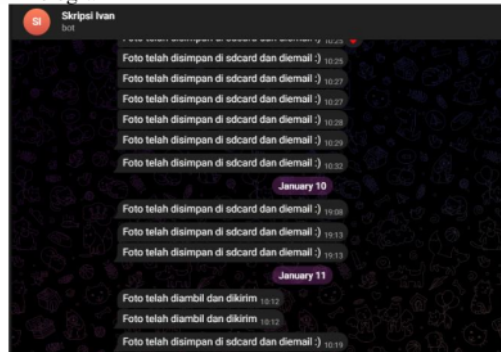

Figure 8. Telegram Notification Display

Source: Researcher Property

Based on figure 7, this telegram application is used to receive notifications from tools such as "photos have been saved on sdcard and emailed" if they have sent images to email and images are saved on sd card. For the appearance of this application can be seen in figure 7.

c. Mail View

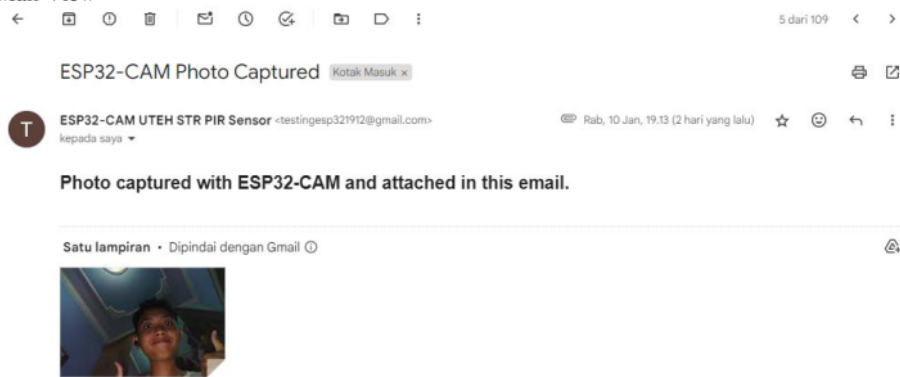

Figure 9. Results of Home Surveillance System Tools

Source: Researcher Property

This application is used to save images sent by the device after the sensor detects movement. For the appearance of this application can be presented in Figure 9. The Mail view displays the state of the picture taken using the camera module and PIR sensor.

DISCUSSIONS

In this research there are several parts of discussion that can be developed. First, further development related to power consumption, home surveillance monitoring devices using Esp32-Cam and SDCard as data storage can be a focus for even better energy efficiency. Further developments related to the integration of monitoring systems with mobile applications such as Blynk or the development of more complex notification systems can also be an interesting focus of research

* Corresponding author



This is an Creative Commons License This work is licensed under a Creative Commons Attribution-NonCommercial-ShareAlike 4.0 International (CC BY-NC-SA 4.0).

Table

Table 1
Tool Power Test Results

| Testing | Condition | Voltage (V) | Current (I) | Watt |
|---------|-----------|---------------|---------------|------|
| 1 | Standby | 5.20 | 160mA | 0.8 |
| 2 | Work | 5.20 | 200mA | 1 |
| 3 | Standby | 5.20 | 160mA | 0.8 |
| 4 | Work | 5.20 | 220mA | 1 |
| 5 | Standby | 5.20 | 160mA | 0.8 |
| 6 | Work | 5.20 | 220mA | 1 |
| 7 | Standby | 5.20 | 160mA | 0.8 |
| 8 | Work | 5.20 | 220mA | 1 |
| 9 | Standby | 5.20 | 160mA | 0.8 |
| 10 | Work | 5.20 | 220mA | 1 |

Based on Table 1, this data provides information on tool performance in 2 modes: standby mode and operating mode. When the standby current flows 160mA and the power produced is 0.8 watts, while when working the current flows 220mA, this indicates that it requires more current when working, the power generated is about 1 watt, by analyzing this data we can see how much power consumption is used. The change in power consumption between standby and working conditions can be seen from how much the current increases when working.

Table 2
Sensor Response Testing with Distance

| Distance | Information | Conclusion |
|----------|-------------------|--------------|
| 1 Meter | There is movement | Detected |
| | No movement | Undetectable |
| 2 Meters | There is movement | Detected |
| | No movement | Undetectable |
| 3 Meters | There is movement | Detected |
| | No movement | Undetectable |
| 4 Meters | There is movement | Detected |
| | No movement | Undetectable |
| 5 Meters | There is movement | Undetectable |
| | No movement | Undetectable |
| 6 Meters | There is movement | Undetectable |
| | No movement | Undetectable |

Testing the sensor's response to distance is carried out with the aim of knowing how far the sensor responds to distance. Based on table 2, sensors are only able to detect objects up to 4 meters more than this, so sensors do not detect this because the quality of the sensor decreases. If the sensor detects an object, it is forwarded with storage to the sd card and delivery of the image to the android.

* Corresponding author



This is an Creative Commons License This work is licensed under a Creative Commons Attribution-NonCommercial-ShareAlike 4.0 International (CC BY-NC-SA 4.0).

Table 3
Data delivery testing

| Testing delivery to- | SDCard | Email | Telegram | Presented |
|----------------------|--------|------------------------|--------------|-----------|
| 1 | Stored | Successfully Delivered | Message Sent | 100% |
| 2 | Stored | Successfully Delivered | Message Sent | 100% |
| 3 | Stored | Successfully Delivered | Message Sent | 100% |
| 4 | Stored | Successfully Delivered | Message Sent | 100% |
| 5 | Stored | Successfully Delivered | Message Sent | 100% |

Table 3 Test results of data submission for each delivery method of the five experiments resulted in a positive response. This shows that the implementation of data transmission has run well and run as expected.

CONCLUSION

Based on the results of the research conducted and described, the author draws the following conclusions:

1. From the results of the analysis on home surveillance monitoring using ESP32-CAM and Sd Card as data storage in steps to form a system to be used in development has been carried out smoothly.
2. Assembling home surveillance monitoring using ESP32-CAM and Sd Card as data storage from the stages that have been carried out to realize at the stage of realizing the system.
3. From the results of tests that have been carried out using the android application and sdcard running well, the PIR sensor can only detect objects as far as 4 meters. Then testing storage to sdcard, sending data on emails and notifications to telegram has run according to the program that has been created.

ACKNOWLEDGMENT

The author expresses his deepest gratitude to God Almighty who has given strength and fortitude during research. The unflinching support and prayers for children from parents who have supported during this research have become a source of inspiration and motivation, and many thanks to the lecturers of Electrical Engineering, Faculty of Science and Technology, University of Muhammadiyah Sidoarjo for their invaluable guidance, insight, and encouragement. Their strong support and commitment play an important role in shaping a writer's academic growth.

REFERENCES

- Asro Laili, Mohamad, Sumiati, and Agung Triayudi. 2022. "Pendekatan Nodemcu Dan Apps Blynk Berbasis Android Untuk Sistem Monitoring Keamanan Kendaraan Motor." *JSiI (Jurnal Sistem Informasi)* 9(2):119–25. doi: 10.30656/jsii.v9i2.5161.
- Desmira, Desmira, Didik Aribowo, Widhi Dwi Nugroho, and Sutarti Sutarti. 2020. "Penerapan Sensor Passive Infrared (PIR) Pada Pintu Otomatis Di Pt LG Electronic Indonesia." *PROSISKO: Jurnal Pengembangan Riset Dan Observasi Sistem Komputer* 7(1). doi: 10.30656/prosisko.v7i1.2123.
- Devi Noviani, Slamet Riyanto. 2020. "Aplikasi Sistem Keamanan Rumah Berbasis Internet of Things Menggunakan Blynk." *Seminar Nasional Teknologi Informasi Dan Komunikasi-2021* 4:405–15.
- Hanafie, Ahmad, Kamal, and Rahmat Ramadhan. 2022. "Perancangan Alat Pendeteksi Gerak Sebagai Sistem Keamanan Menggunakan ESP32 CAM Berbasis IoT." *Jurnal Teknologi Dan Komputer (JTEK)* 2(02):142–48. doi: 10.56923/jtek.v2i02.101.
- Ipanhar, A., Toni Kusuma Wijaya, and Pamor Gunoto. 2022. "Perancangan Sistem Monitoring Pintu Otomatis Berbasis Iot Menggunakan Esp32-Cam." *Sigma Teknika* 5(2):333–50. doi: 10.33373/sigmateknika.v5i2.4590.
- Joan, Joan, Zulfian Azmi, and Ardianto Pranata. 2022. "Implementasi Iot (Internet Of Things) Untuk Spy Jacket Dengan Berbasis Esp32-Cam." *Jurnal Sistem Komputer Triguna Dharma (JURSIK TGD)* 1(4):142. doi: 10.53513/jursik.v1i4.5591.
- M, Ardiansyah, Aldi Febryan, Andriani, and Rahmania. 2023. "Rancang Bangun Sistem Keamanan Rumah Berbasis

* Corresponding author



This is an Creative Commons License This work is licensed under a Creative Commons Attribution-NonCommercial-ShareAlike 4.0 International (CC BY-NC-SA 4.0).

- Telegram Menggunakan Esp 32 Cam." *Jurnal Teknik Elektro UNIMUH* 15(1):64–71. doi: <https://doi.org/10.26618/jte.v15i1.10246>.
- Muhamad Satibi Mulya, Indra Yustiana, Ivana Lucia Khrisma. 2022. "Jurnal Computer Science and Information Technology (CoSciTech)." 3(3):371–81. doi: <https://doi.org/10.53513/jursik.v1i1.4795>.
- Nur Atikah, Tuti Hartati, Agus Bahtiar, Kaslani, and Odi Nurdiawan. 2022. "Sistem Image Capturing Menggunakan ESP32-Cam Untuk Memonitoring Objek Melalui Telegram." *KOPERTIP : Jurnal Ilmiah Manajemen Informatika Dan Komputer* 6(2):49–53. doi: 10.32485/kopertip.v6i2.141.
- Pitaloka, Pera, Ishak, and Jufri Halim. 2021. "Implementasi Internet of Things (IOT) Pada Sistem Monitoring Rumah Dengan Esp Cam Berbasis Mikrokontroler." *Jurnal CyberTech* 4(1):1–9.
- Rahmawati, Yosy, Imelda Uli Vistalina Simanjuntak, and Rianka Bayu Simorangkir. 2022. "Rancang Bangun Purwarupa Sistem Peringatan Pengendara Pelanggar Zebra Cross Berbasis Mikrokontroler ESP-32 CAM." *Jambura Journal of Electrical and Electronics Engineering* 4(2):189–95. doi: 10.37905/jjee.v4i2.14499.
- Ramschie, A., J. Makal, and R. Katuuk. 2021. "Pemanfaatan ESP32 Pada Sistem Keamanan Rumah Tinggal Berbasis IoT." *Workshop and National* 4–5.
- Rifaini, Arinda, Sanriomi Sintaro, and Ade Surahman. 2022. "Alat Perangkap Dan Kamera Pengawas Dengan Menggunakan Esp32-Cam Sebagai Sistem Keamanan Kandang Ayam." *Jurnal Teknik Dan Sistem Komputer* 2(2):52–63. doi: 10.33365/jtikom.v2i2.1486.
- Selvam, Dr P. D., K. Nikhil, K. Ranjitha Reddy, A. Mounika, P. Reddy Sekhar, M. Reddy, and Siva Sai. 2022. "Surveillance Monitoring Using Esp32-Cam Module." *International Journal of Creative Research Thoughts* 10(4):660–65.
- Setiawan, Andi, and Ade Irma Purnamasari. 2019. "Pengembangan Passive Infrared Sensor (PIR) HC-SR501 Dengan Microcontrollers ESP32-CAM Berbasiskan Internet of Things (IoT) Dan Smart Home Sebagai Deteksi Gerak Untuk Keamanan Perumahan." *Prosiding Seminar Nasional SISFOTEK (Sistem Informasi Dan Teknologi Informasi)* 3(1):148–54.
- Setiawan, Dedi, Hendra Jaya, Saiful Nurarif, Trinanda Syahputra, and Muhammad Syahril. 2022. "Implementasi Esp32-Cam Dan Blynk Pada Wifi Door Lock System Menggunakanteknik Duplex." *Journal of Science and Social Research* 5(1):159. doi: 10.54314/jssr.v5i1.807.
- Studi, Program, Teknik Elektro, and Universitas Muhammadiyah Sidoarjo. 2022. "Sistem Camera Dan Pengamanan Kotak Amal Berbasis Internet Of Things Dan Telegram." *SinarFe7* 5(1):44–48.
- Sugiyono. 2013. *Metode Penelitian Kuantitatif, Kualitatif, Dan R&D*. Bandung: Alfabeta.
- Susana, Ratna, Muhammad Ichwan, and Savero Al Phard. 2018. "Penerapan Metoda Serial Peripheral Interface (SPI) Pada Rancang Bangun Data Logger Berbasis SD Card." *ELKOMIKA: Jurnal Teknik Energi Elektrik, Teknik Telekomunikasi, & Teknik Elektronika* 4(2):208. doi: 10.26760/elkomika.v4i2.208.
- Wicaksono, Mochamad Fajar, and Myrna Dwi Rahmatya. 2020. "Implementasi Arduino Dan ESP32 CAM Untuk Smart Home." *Jurnal Teknologi Dan Informasi* 10(1):40–51. doi: 10.34010/jati.v10i1.2836.
- Wisaksono, Arief, and Muhammad Umar Mokhtar. 2022. "Kontrol Lampu Otomatis Dengan Sistem Hybrid." *Cakrawala Ilmiah* 1(10):2359–66.

* Corresponding author



This is an Creative Commons License This work is licensed under a Creative Commons Attribution-NonCommercial-ShareAlike 4.0 International (CC BY-NC-SA 4.0).

ORIGINALITY REPORT

15%

SIMILARITY INDEX

15%

INTERNET SOURCES

6%

PUBLICATIONS

3%

STUDENT PAPERS

PRIMARY SOURCES

1

forestsnews.cifor.org

Internet Source

3%

2

infor.seaninstitute.org

Internet Source

3%

3

eprints.bsi.ac.id

Internet Source

3%

4

stmik-budidarma.ac.id

Internet Source

2%

5

zagan.unizar.es

Internet Source

2%

Exclude quotes Off

Exclude matches < 2%

Exclude bibliography On