



TERAKREDITASI INSTITUSI B  
SK NO. 229/BAN-  
PT/AKRED/PT/IV/2015

# UNIVERSITAS MUHAMMADIYAH SIDOARJO

## DIREKTORAT RISET DAN PENGABDIAN MASYARAKAT

Alamat: Jl. Mojopahit 666 B Sidoarjo 61215, Telp. 031-8945444 psw.130, Faks. 031-8949333 Email:  
lppm@umsida.ac.id, Website: lppm.umsida.ac.id

### Surat Keterangan Tidak Plagiat [Kepangkatan]

Nomor: 776.5/II.3.AU/14.00/C/KET/I/2023

Kepada Yth :  
Bpk. Izza Anshory, ST., MT., Dr.  
Di  
Tempat

*Assalamua'alaikum Wr. Wb.*

Sehubungan dengan adanya permohonan Surat Keterangan Tidak Plagiat dengan rincian:

Judul Artikel : Transfer Function Modeling And Optimization Speed Response Of  
Blde Motor E-Bike Using Intelligent Controller

Nama Pemohon : Izza Anshory / TEKNIK ELEKTRO

URL Sinta Pemohon : <https://sinta.kemdikbud.go.id/authors/profile/5993144>

Nama Penulis : Izza Anshory

Tujuan : Kepangkatan

Tujuan Kepangkatan : Lektor

Naskah Yang Dimohonkan pengecekan:

<https://dosen.umsida.ac.id/modul/publikasi/filesktp/202239/sktp-10-01-2023%2002:10:52-202239.pdf>

**Artikel tersebut DAPAT digunakan untuk proses kepangkatan.**

Demikian surat keterangan ini kami sampaikan, mohon untuk digunakan sebagaimana mestinya.

*Wassalamu'alaikum Wr. Wb.*

Mengetahui,  
Wakil Rektor 1  
Universitas Muhammadiyah Sidoarjo



Hana Catur Wahyuni, ST., MT

Direktur DRPM

Universitas Muhammadiyah Sidoarjo



Dr. Sigit Hermawan, S.E., M.Si

# sktp-10-01-2023 02\_10\_52- 202239

*by Izza Anshory, St., Mt., Dr.*

---

**Submission date:** 11-Jan-2023 09:03AM (UTC+0700)

**Submission ID:** 1991011081

**File name:** sktp-10-01-2023\_02\_10\_52-202239.pdf (999.14K)

**Word count:** 5856

**Character count:** 29710

## TRANSFER FUNCTION MODELING AND OPTIMIZATION SPEED RESPONSE OF BLDC MOTOR E-BIKE USING INTELLIGENT CONTROLLER

IZZA ANSHORY<sup>1,2,\*</sup>, IMAM ROBANDI<sup>1</sup>,  
JAMAALUDDIN<sup>1,2</sup>, AHMAD FUDHOLI<sup>3</sup>, WIRAWAN<sup>1</sup>

<sup>1</sup>Department of Electrical Engineering, Faculty of Intelligent Electrical and Informatics  
Technology, Institut Teknologi Sepuluh Nopember (ITS)

Jl. Raya ITS, Keputih, Sukolilo, 60111, Surabaya, Indonesia

<sup>2</sup>Department of Electrical Engineering, Universitas Muhammadiyah Sidoarjo,

Jl. Raya Gelam No.250, 61271, Sidoarjo, Indonesia

<sup>3</sup>Solar Energy Research Institute, Universiti Kebangsaan Malaysia

\*Corresponding Author: izza.anshory15@mhs.ee.its.ac.id

### Abstract

The applications of electric bikes (e-bikes) as the alternative vehicles are growing significantly in recent years. Brushless Direct Current (BLDC) motor is an essential component in an e-bike, which is used to actuating element of the e-bike. Besides that, to get the best performance from e-bike, BLDC motor speed control is significant. This research aims to compare the optimal transient response on a BLDC motor speed control system that is optimized using a combination of intelligent control. Intelligent control compared in this research is a combination of fuzzy logic with Proportional Integral Derivative (PID), which is optimized by Particle Swarm Optimization (PSO) and Firefly Algorithm (FA). Transient responses measured are rise time, settling time, overshoot, and Integral Time Absolute Error (ITAE). The method used in this study consists of two parts: the first is mathematical modeling a BLDC motor in the form of a transfer function equation through system identification and the second is the tuning of PID controller parameters using PSO, FA, and hybrid PSO or FA. From the result of experiments and simulation, it is observed that hybrid fuzzy PID based on the firefly algorithm provides the best performance compared to other scenarios.

**Keywords:** BLDC motor, Firefly algorithm, Fuzzy logic, PID controller, PSO.

## 1. Introduction

Some of the problems that are happening right now in some countries of the world are the increasing amount of CO<sub>2</sub> emissions, the reduced availability of non-renewable natural resources, the limited availability of parking locations, and air pollution [1, 2]. Based on these problems, it is necessary to have alternative vehicles that can solve some of these problems at affordable prices by the community, namely e-bikes [3]. E-bikes are very beneficial for students who go to school or campus, mothers who go to the market or shop and to law enforcers such as the police in large cities where parking and traffic is a problem [4]. The e-bike components generally consist of batteries, throttles, controllers, mechanical frames, and BLDC motor [5]. Some of the advantages possessed by BLDC motor use as driving bicycles, including durable, easy maintenance, not noisy, has a torque that is proportional to its speed [3]. In general, BLDC motors used in e-bikes in American, Japanese, Australian, and Chinese countries range from 200-750 Watts [1].

The performance of electric bikes can improve in several ways, including modifying the physical design, mechanics, and optimization of the speed control of the BLDC motor [6]. Before optimization, the BLDC motor was modeled by mathematically. Two types of modeling implemented in each system identification, namely theoretically, and experimentally. Theoretical modeling, meaning modeling is done based on the laws of physics. While modeling with an experimental approach indicates collecting input and output data by measuring a system. Also, to identify the system in experimental modeling, it is divided into two types, namely non-parametric and parametric. In a parametric approach, the modeling identification structure was divided into four, such as Box-Jenkins (BJ), Auto-Regressive with external input (ARX), Output-Error (OE), and Auto-Regressive Moving Average with external input (ARMAX) [7]. Whereas for non-parametric modeling such as transfer function, differential or difference Equation [7]. The stages of system identification carried out through experiments for input and output data collection [7, 8].

There are several optimization methods for speed control of BLDC motor which have been investigated, such as the Proportional Integral Derivative (PID) controller [9], fuzzy logic controller [10, 11] and neural network controller [12]. The PID controller is widely used to improve the performance of BLDC motor, because of several advantages, namely simple structure, strong reliability, easy to use. But in addition to having edges, PID controllers have a disadvantage of having to set the right parameters, which was done through trial-and-error methods [13].

Neural network, fuzzy logic, and evolution algorithm used for tuning PID controller parameters [14]. Evolution algorithm from natural sources, such as Particle Swarm Optimization (PSO) [15], Bat Algorithm (BA) [16], Firefly Algorithm (FA) [17], and Cuckoo Search Algorithm (CSA) [18]. In addition to the performance of BLDC electric motor speed control, it can also be done by combining fuzzy logic with intelligent search algorithms.

This study aims to optimize the speed control of the BLDC motor using a combination of intelligent controls to obtain an optimal transient response. The combination of fuzzy logic intelligent control with PID controller optimized by the PSO algorithm and the firefly algorithm used as an optimization method. Then the results of the optimization are compared to find the best transient response.

## 2. System Identification of BLDC Motor e-Bike

System identification and modeling of the BLDC motor were made through experiments to obtain mathematical modeling. Experiment data from the BLDC motor e-Bikes were chosen based on initializing knowledge about the identification process, such as the mathematical model of the previous experiment, and operating conditions when carried out measurements.

Figure 1 shows the parts of the e-bike, with the BLDC motor as the main component with specifications of 350 W, 400 rpm, and 48 Volts. The equation of the BLDC motor plant transfer function obtained through the system identification. The process of identifying the physical structure system of a BLDC motor shown in Fig. 2.



Fig. 1. BLDC motor of an e-bike.

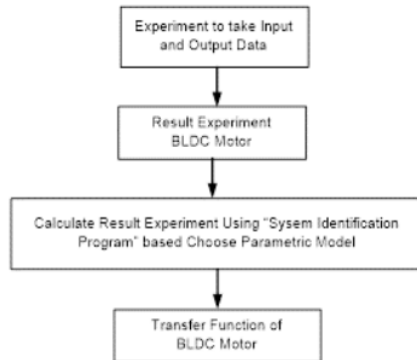

Fig. 2. System identification of BLDC motor.

One method of system identification in obtaining a mathematical model for a BLDC motor plant is through the transfer function model as given in Eq. (1) [19, 20].

$$y(t) = G(q, \theta)u(t) + H(q, \theta)e(t) \quad (1)$$

where  $q$  is the shift operator, such that  $qu(t) = u(t + 1)$  and  $q^{-1}u(t) = u(t - 1)$ , and  $e(t)$  is a white noise sequence. Unknown system parameters can be described through rational functions and coefficients with  $G(q, \theta)$  and  $H(q, \theta)$ . General structure is

$$A(q)y(t) = \frac{B(q)}{F(q)}u(t) + \frac{C(q)}{D(q)}e(t) \quad (2)$$

where the polynomials are described by

$$X(q) = 1 + x_1q^{-1} + \dots + x_{n_x}q^{-n_x} \tag{3}$$

where  $X$  is  $A, C, D, F$  and  $n_x$  is the order of the polynomial. There is a possible delay  $n_k$  in  $B(q)$ ,

$$B(q) = b_{n_k}q^{-n_k} + \dots + X_{n_k+n_b-1}q^{-(n_k+n_b-1)} \tag{4}$$

$$y(t) = \frac{B(q)}{F(q)}u(t) + e(t) \tag{5}$$

### 3. Optimization of Speed Controller

Some intelligent algorithms such as fuzzy logic, PSO algorithms, and firefly algorithms used to get the PID controller parameters and improve performance speed control of BLDC motor.

In Fig. 3, describes proposed research on the identification and implementation of a combination of fuzzy logic and PID controller which is optimized by the intelligent search algorithm PSO and firefly algorithm to increase the speed of response of BLDC motors.

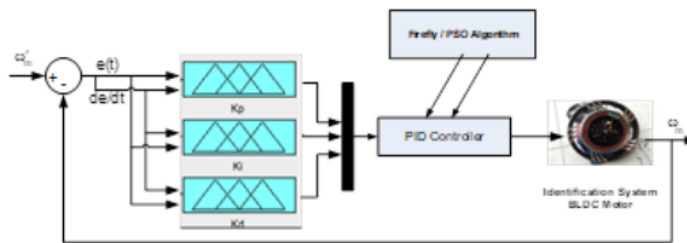

Fig. 3. Optimization speed response of BLDC motor.

#### 3.1. PID controller

In general, the control system divided into two types first is a system whose output is no feedback (open loop) and a system that uses sensor to minimize error (close loop). With this sensor, the output becomes more optimal. The PID controller consists of proportional gain, integral gain, and derivative gain, as shown in Fig. 4 [21].

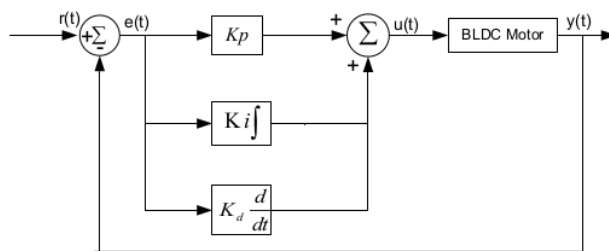

Fig. 4. Block diagram of PID controller.

The mathematical equation for the PID controller can be formulated as follows

$$u(t) = K_p \cdot e(t) + K_i \int_0^t e(t) dt + K_d \frac{de}{dt} \quad (6)$$

In Eq. (6), it can be explained that  $k_p$  will reduce rise time,  $k_i$  will eliminate the steady-state error, but it will cause transient response blander and make oscillations occur, while for  $k_d$  will cause increased system stability, reduce overshoot, and increase transient response.

### 3.2. Method of Fuzzy Logic Controller

The fuzzy logic control method is an intelligent system control method based on the knowledge base that is owned and uses Fuzzy logic to make decisions on controlled objects [22-26].

Figure 5 explains that fuzzy logic controllers are used to tuning the parameters  $k_p$ ,  $k_i$ , and  $k_d$ . There are two inputs, namely error (e) and delta error (ec). While the output is three outputs that will be controlled for the value to be adjusted automatically.

The number of values chosen for linguistic variables for input  $\{-400, -300, -200, -100, 0, 100, 200, 300, 400\}$ , then for delta errors have values  $\{-100, -80, -60, -40, -20, 0, 20, 40, 60, 80\}$ . While the output value has a range of  $\{0, 0.5, 1, 1.5, 2, 2.5, 3, 3.5, 4, 4.5, 5\}$ .

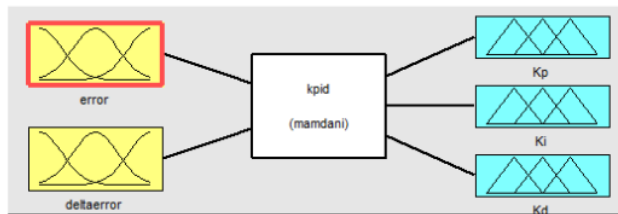

Fig. 5. FIS editor.

Figures 6 and 7 explain that there are seven linguistic variables used for input and output membership function.

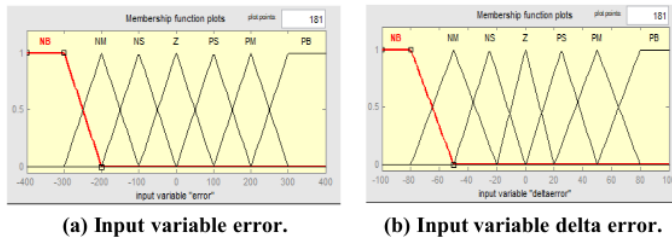

Fig. 6. Fuzzy logic membership function input.

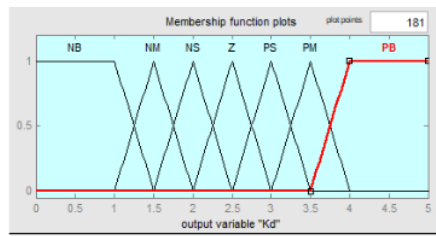

Fig. 7. Fuzzy logic membership function plot for output.

In Tables 1, 2, and 3, show there are 49 relationships between inputs, namely error and delta error with the output for the values of  $k_p$ ,  $k_i$ , and  $k_d$ . Table 1, which shows each rule uses an If - Then logic of the following form pairs of input relations and  $k_p$  output.

2 Table 1. Fuzzy rule base for  $k_p$ .

e\de	NB	NM	NS	Z	PS	PM	PB
NB	NB	NB	NB	NM	NS	NS	Z
NM	NB	NM	NM	NM	NS	Z	PS
NS	NB	NM	NS	NS	Z	PS	PM
Z	NB	NM	NS	Z	PS	PM	PB
PS	NM	NS	Z	PS	PS	PM	PB
PM	NS	Z	PS	PM	PM	PM	PB
PB	Z	PS	PS	PM	PB	PB	PB

Table 2. Fuzzy rule base for  $k_i$ .

e\de	NB	NM	NS	Z	PS	PM	PB
NB	NB	NB	NM	NM	NS	Z	Z
NM	NB	NB	NM	NS	NS	Z	Z
NS	NB	NM	PS	NS	Z	PS	PS
Z	NM	NM	NS	Z	PS	PM	PM
PS	NM	NS	Z	PS	PS	PM	PB
PM	Z	Z	PS	PS	PM	PB	PB
PB	Z	Z	PS	PM	PM	PB	PB

7 Table 3. Fuzzy rule base for  $k_d$ .

e\de	NB	NM	NS	Z	PS	PM	PB
NB	PS	NS	NB	NB	NB	NM	PS
NM	PS	NS	NB	NM	NM	NS	Z
NS	Z	NS	NM	NM	NS	NS	Z
Z	Z	NS	NS	NS	NS	NS	Z
PS	Z	Z	Z	Z	Z	Z	Z
PM	PM	NS	PS	PS	PS	PS	PB
PB	PB	PM	PM	PM	PS	PS	PB

Fuzzy rules, combined with PID controllers, are designed to update controller parameters based on variations in errors and the rate of change in output errors at each step.



### 3.3. PSO Algorithm for optimization PID controller

Particle Swarm Optimization (PSO) is an algorithm of optimization inspired by the social behaviour of bird or fish movements (bird flocking or fish schooling), which was initially introduced by James Kennedy and Russell C. Eberhart in the mid-1990s [27]. Each called a particle moves around the search space and adjusts it based on personal experience and particle experience next to it. PSO algorithm combines local search methods with global search methods [28].

Each particle has a position  $x_i = (x_{i1}, x_{i2}, \dots, x_{in})$  and velocity  $v_i =$  (in the  $N$ -dimensional search space, where  $i$  represents the  $i$ th particle and  $N$  denotes the dimensions of the search space or the number of unknown variables.

$$v_k^i = wv_k^i + c_1r_1(pbest_i^k - x_i^k) + c_2r_2(gbest^k - x_i^k) \tag{7}$$

$$x_i^{k+1} = x_i^k + v_i^{k+1} \tag{8}$$

Figure 8 explains the flowchart of the PSO algorithm, each particle moves into a new position in the search space and will remember as the best personal (Pbest). In addition, in addition to the information memory itself, each particle will also exchange information with other particles and remember as the global best (Gbest).

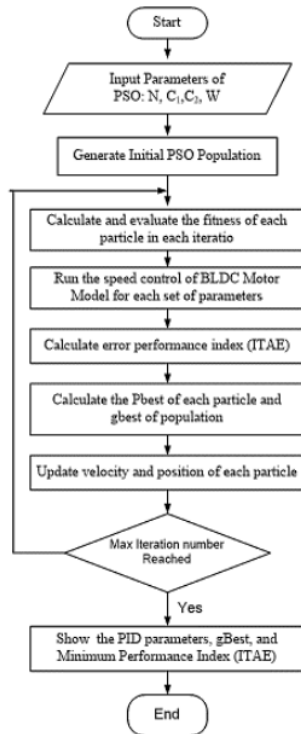

Fig. 8. Flowchart of PSO algorithm.

Table 4 shows the PSO parameters used to obtain the optimal solution.

**Table 4. Proposed parameter value.**

Number of Particle	20
Number of Iteration	50
C <sub>1</sub> (Social Constant)	2
C <sub>2</sub> (Cognitive Constant)	2
Inertia weight	0.9

### 3.4. Firefly algorithm for optimization PID controller

The Firefly (FA) algorithm is a metaheuristic algorithm inspired by nature that comes from the behaviour characteristics of flickering fireflies. This algorithm defined by Dr. Xin-She Yang from the University of Cambridge, the UK in 2008 [29]. The purpose of firefly's flash is to act as a signal system to attract other fireflies. The firefly algorithm has three basic rules, namely all fireflies are unisex, so fireflies will be attracted to other fireflies with **6**t looking at gender, the attractiveness of fireflies is proportional to the brightness, if there are no fireflies that have Brightest brightness, then fireflies will move randomly, the light intensity of fireflies is determined by the value of the objective function of the problem given [30, 31]. Figure 9 shows the flowchart design for tuning the PID controller using the Firefly algorithm.

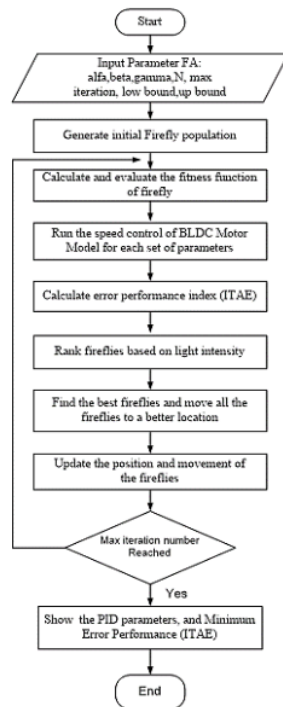

**Fig. 9. Flowchart of firefly algorithm.**



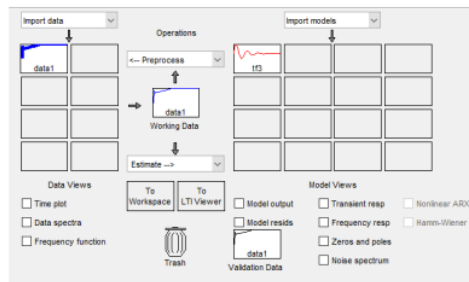

Fig. 10. System identification toolbox for BLDC motor.

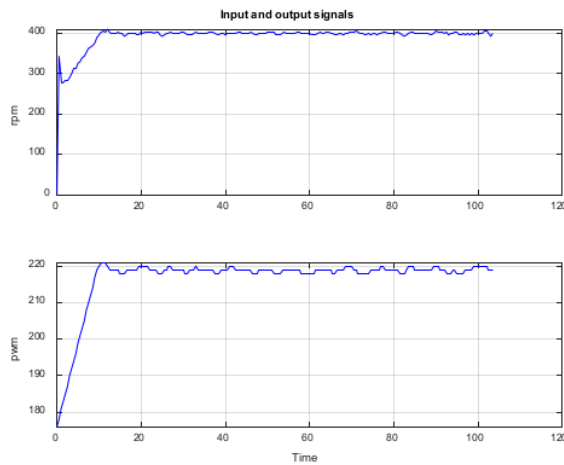

Fig. 11. Input and output signal of BLDC motor.

Input and output data obtained from the instrumentation were simulated using the MATLAB System Identification Toolbox (SIT) to obtain the BLDC motor transfer function equation as follows.

$$G(s) = \frac{3544s + 7630}{s^3 + 21.39s^2 + 2080s + 4172} \quad (12)$$

The results of these equations then used as a basis for optimizing using the intelligent controller of the hybrid fuzzy PID controller.

#### 4.2. Transient response for open loop system

In the design of the control system, the performance characteristics desired by the system must be specified in the form of time domain. On generally, this specification is given for the response of the unit step function which is considered to represent the overall system performance.

In Fig. 12, explaining the result for open-loop transient response of the BLDC motor drive system. The results of the open loop test on the BLDC motor are given in Fig. 12, indicating that when the BLDC motor is given a step unit input, the BLDC motor at the start experiences a large oscillation, and progresses to stability. This test shows that the BLDC motor model can run properly according to the field. The result of speed responses values for rise time is 0.0282 second, and settling time is 0.4671 second, and overshoot is 43.2268.

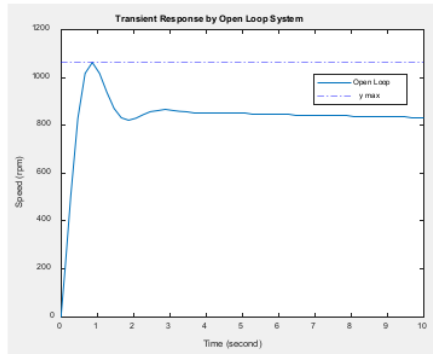

Fig. 12. Transient response of BLDC motor.

#### 4.3. Transient response for close loop system

To find out the transient response in the close loop system, it is simulated in several stages, including using optimization with PID controllers, fuzzy, and hybrid fuzzy and PID controllers.

The results for the PID controller system include speed response indicators, such as rise time, settling time, and overshoot. The simulation results graph is shown in Fig. 13. From the simulation results values for rise time is 0.0224 second, settling time is 3.6158 second and overshoot is 8.8465.

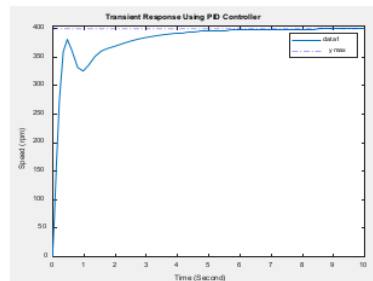

Fig. 13. Transient response for PID controller.

By looking at these results, the speed response can be said to be inadequate, and requires additional controllers

#### 4.4. Optimization BLDC motor using fuzzy PID controller

The system output response for the BLDC motor system in the open loop results in excessive oscillation, causing overall system instability. Therefore, a fuzzy logic control system designed that is relatively good in producing an output response.

After designing the rules with input combinations in the form of errors and delta error, there are 49 rules for each output  $k_p$ ,  $k_i$ , and  $k_d$ . So that the surface viewer obtained as shown in Fig. 14, which represents the fuzzy-PID controller.

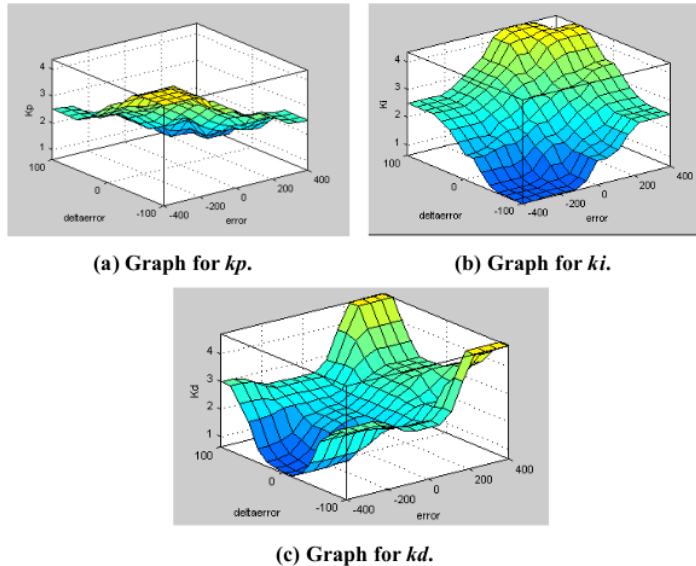

Fig. 14. Surface viewer of fuzzy-PID controller.

#### 4.5. PSO and Firefly algorithm for optimization PID controller

In this paper, it is proposed to use intelligent controllers to determine the right parameters for PID controller, which were previously conducted by [10] trial and error. Optimal PID controller parameters are obtained through tuning  $K_p$ ,  $K_i$ , and  $K_d$  parameters using different methods namely PSO and FA, so that the optimal transient response value is obtained. The Simulink block model to get the optimal PID controller parameters using the PSO and FA algorithm is shown in Fig. 15. The parameters namely  $k_p$ ,  $k_i$ , and  $k_d$  are optimized using the PSO algorithm so that an optimal value is obtained. The next step is to optimize the PID parameters again using the Firefly algorithm, which then compares the results of the two algorithms.

Optimization results for the PID controller parameters using the PSO algorithm obtained values for  $k_p$ ,  $k_i$ , and  $k_d$  are 10.2297, 9.8083, 0.7631, and for the PID controller optimized using the firefly algorithm the values for  $k_p$ ,  $k_i$ , and  $k_d$  are 18.1891, 3.6286, and 0.8187.

Figure 16 shows a graph of the comparison speed response of a BLDC motor using the PSO and Firefly Algorithm tuning parameters  $k_p$ ,  $k_i$ , and  $k_d$ .

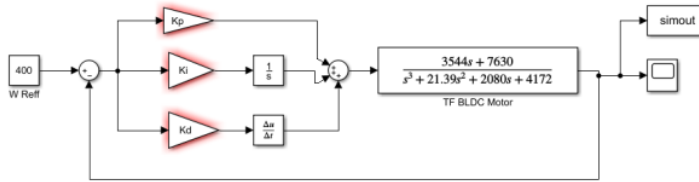

Fig. 15. Simulink model for optimization PID using PSO and FA.

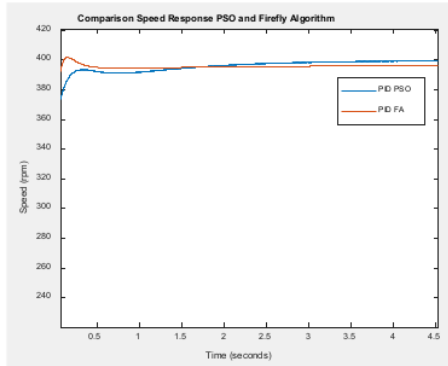

Fig. 16. Comparison speed response of BLDC motor.

To evaluate the stability of the system, we use Integral Time Absolute Error (ITAE).

$$ITAE = \int_0^t t|\Delta\omega * t(t)|dt \quad (13)$$

Figure 17 explains the behaviour of an animal in a swarm (swarm) is influenced by the behaviour of individuals and their groups, so keep in mind that the best position of the individual and the best position groups need to be saved for the overall iteration.

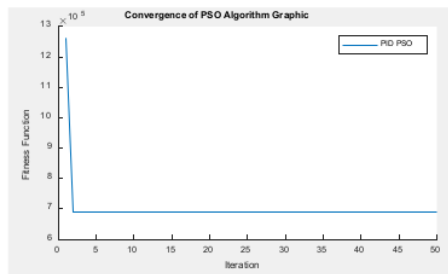

Fig. 17. Convergence properties of PSO algorithm.

The PSO optimization results obtained the best global:  $1.263e + 06$ , and value ITAE:  $2.3495e+05$  with 50 iterations.

Figure 18 shows about the Firefly algorithm optimization results obtained for lightbest on firefly algorithm the value was obtained:  $3.49e+06$ , and ITAE:  $2.9715e+05$  with 50 iterations.

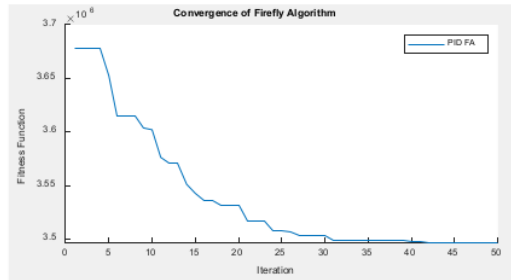

Fig. 18. Convergence properties of Firefly algorithm.

#### 4.6. Comparison of optimization hybrid Fuzzy-PID controller with PSO and Firefly algorithm

The purpose of the proposed hybrid fuzzy-PID controller is optimized using the PSO and Firefly algorithms to compare between the two intelligent algorithms which are better at improving control performance in the form of reducing overshoot and settling time. In Fig. 19 showed the Simulink model for comparison of the two intelligent controllers.

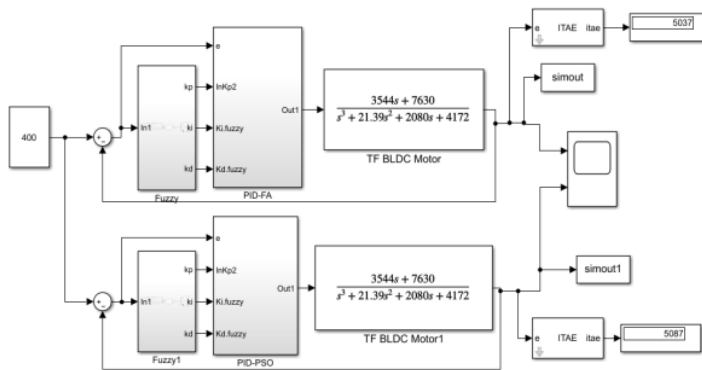
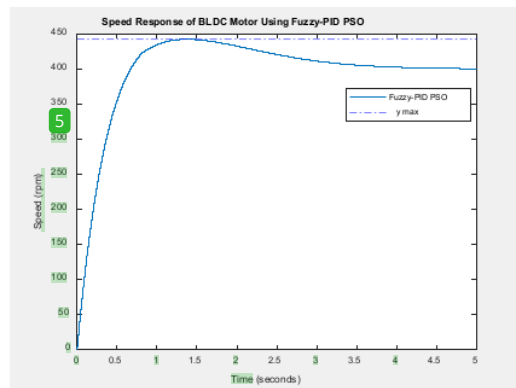

Fig. 19. Simulink model for Fuzzy-PID PSO or FA.

Figure 20 shows the simulation result for optimizing the combination of the fuzzy logic controller with PID-PSO.





**Fig. 20. Speed response of Fuzzy-PID PSO algorithm.**

Figure 21 illustrates a graph of the optimization results for a combination of fuzzy logic with PID controller and firefly algorithm.

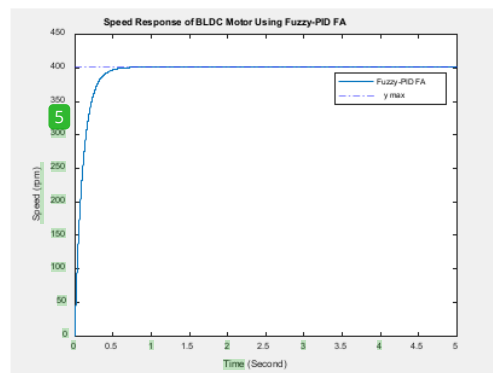

**Fig. 21. Speed response of Fuzzy-PID FA.**

Figure 22 plots the speed response comparison for both the Fuzzy-PID Firefly algorithm and the Fuzzy-PID PSO algorithm intelligent algorithm. From the graph, it can see that Fuzzy-PID which optimized by the firefly algorithm can reduce the occurrence of overshoot and better settling time.

Based on the planned system target is the achievement of the speed in accordance with the set point specified in the BLDC motor plant system. And to test the control system that has been made to get good results, it is given a disturbance in the form of large changes in the error of the system as an input variable in the fuzzy inference system. In Figs. 19 and 22 showed that the combination of fuzzy PID PSO can maintain the stability of the system according to the set point, it is just that when interference occurs, the system experiences an overshoot before achieving stability.

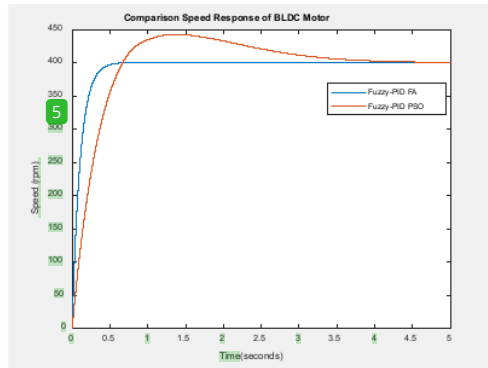

**Fig. 22. Comparison optimization Fuzzy PID Controller.**

Figure 23 shows a comparison between all the methods used in the proposed research, namely open loop, close-loop, PID controller, fuzzy and PID controller optimized with PSO algorithm or Firefly algorithm. From Fig. 23 shows about the system when it is in an open loop position, overshoot occurs. After being given a gradual optimization method, there is an increase in system control performance. Table 6 shows the value of performance resulting from the optimization process with intelligent controller.

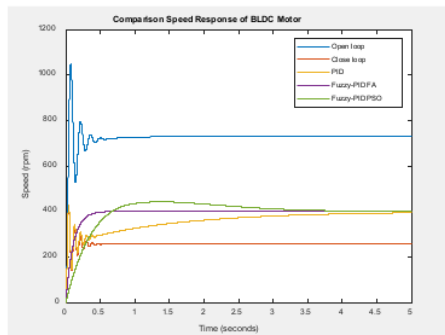

**Fig. 23. Speed response optimization of BLDC motor.**

**Table 6. Result performance optimization for speed response.**

Type of Optimization	Parameter of Speed Response			
	Rise time	Settling Time	Overshoot	ITAE
PID PSO	0.1592	0.2668	0.7673	2.3495e+05
PID-FA	0.1118	0.2463	0.2134	2.9715e+05
Fuzzy PID-PSO	0.3975	2.7182	9.7158	5.087e+03
Fuzzy PID-FA	0.3411	0.5703	1.0026	5.037e+03

## 5 Conclusion

This paper presents mathematical modeling of the BLDC motor e-bike and compares the effects with or without optimization on speed response. The optimization method is implemented on the BLDC motor e-bike system including PID controller, fuzzy logic combined with PID controller which is optimized by PSO and Firefly algorithms. A combination of experimental and simulation methods has been carried out to obtain input, output, BLDC motor mathematical models, and speed response indicators. Speed response indicators used for optimization evaluation include rise time, settling time, overshoot, and ITAE value. Some of the results obtained from the proposed study include a mathematical model of the BLDC motor e-bike in the form of a transfer function, better speed response when optimized with the fuzzy-PID Firefly hybrid algorithm compared to the Fuzzy-PID PSO.

## Acknowledgment

The authors would like to thank the Indonesian government for the BPPDN scholarship for their assistance through the scholarship program for Indonesian education, Institut Teknologi Sepuluh Nopember Surabaya and Universitas Muhammadiyah Sidoarjo who have provided opportunities and guidance to carry out this doctoral dissertation research.

### Nomenclatures

$C_1$	Social Constant
$C_2$	Cognitive Constant
$G_{best}$	Global Best
$K_d$	Gain Derivative
$K_i$	Gain Integral
$K_p$	Gain Proportional
$NB$	Negative Big
$NM$	Negative Medium
$NS$	Negative Small
$PB$	Positive Big
$P_{best}$	Personal Best
$PM$	Positive Medium
$PS$	Positive Small
$Z$	Zero

### Greek Symbols

$\alpha$	A random selection parameter.
$\beta$	Attractiveness
$\gamma$	light absorption coefficient

### Abbreviations

BLDC	Brushless Direct Current
CSA	Cuckoo Search Algorithm
E-Bike	Electric Bike
FA	Firefly Algorithm

FIS	Fuzzy Inference System
ITAE	Integral Time Absolute Error
PID	Proportional Integral Derivative
PSO	Particle Swarm Optimization
PWM	Pulse Width Modulation
SIT	System Identification Toolbox

## References

1. McLoughlin, I.V.; Narendra, I.K.; Koh, L.H.; Nguyen, Q.H.; Seshadri, B.; Zeng, W.; and Yao, C. (2012). Campus mobility for the future: The e-bike. *Journal of Transportation Technologies*, 02(1), 1-12.
2. Buyuk, O.O.; and Bilgin, S.N. (2016). A novel application to increase energy efficiency using artificial neural networks. *4th International Istanbul Smart Grid Congress and Fair*. Istanbul, Turki, 1-5.
3. Trivedi, M.M.; Budhvani, M.K.; Sapovadiya, K.M.; Pansuriya, D.H.; and Chirag, D. (2017). Design & development of e-bike a review. *Iconic Research and Engineering Journal*, 1(5), 36-43.
4. Cerone, V.; Andreo, D.; Larsson, M.; and Regruto, D. (2010). Stabilization of a riderless bicycle applications of control. *IEEE Control System Magazine*, 30(5), 23-32.
5. Gromba, J. (2018). Torque control of BLDC motor for e-bike. *International Symposium on Electrical Machines, SME*. Andrychów, Poland, 1-5.
6. Florez, D.; Carrillo, H.; Gonzalez, R.; Herrera, M.; Hurtado-Velasco, R.; Cano, M.; Roa, S.; and Manrique, T. (2018). Development of a bike-sharing system based on pedal-assisted electric bicycles for Bogota City. *Electronics Journal*, 7(11).
7. Anshory, I.; Robandi, I.; and Wirawan. (2018). Identification and optimization speed control of BLDC motor using fuzzy logic controller. *International Journal of Engineering and Technology*, 7(2.14), 267-271.
8. Araydah, W.; Tutunji, T.A.; and Al-naimi, I. (2017). System identification for a liquid flow process. *IEEE Jordan Conference on Applied Electrical Engineering and Computing Technologies*. Aqaba, Jordan, 1-6.
9. Shekhar, S.; Saha, P.K.; and Thakura, P.R. (2019). Optimal PID tuning of blde drive using lqr technique. *IEEE International Conference on Intelligent Systems and Green Technology*. Visakhapatnam, India, 57-574.
10. De Maity, R.R.; and Mudi, R.K. (2014). Fuzzy logic based high performance PID controller. *IEEE 8th International Conference on Intelligent Systems and Control*. Coimbatore, India, 183-187.
11. Jayetileke, H.R.; de Mel, W.R.; and Ratnayake, H.U.W. (2017). Modelling and simulation analysis of the genetic-fuzzy controller for speed regulation of a sensed BLDC motor using MATLAB/Simulink. *IEEE International Conference on Industrial and Information Systems*. Peradeniya, Srilanka, 1-6.
12. Ho, T.; Huynh, C.; Lin, J.; and Hu, P. (2018). The study of a neural network-based motor drive for a range hood. *3rd International Conference on Intelligent Green Building and Smart Grid*. Yilan, Taiwan, 1-4.

13. Chao, C.T.; Sutarna, N.; Chiou, J.S.; and Wang, C.J. (2017). Equivalence between fuzzy PID controllers and conventional PID controllers. *Applied Sciences*, 7(6), 513.
14. Robandi, I. (2019). *Artificial Intelligence*. Yogyakarta: Penerbit Andi.
15. Anshory, I.; Robandi, I.; and Wirawan. (2016). Monitoring and optimization of speed settings for brushless direct current (BLDC) using particle swarm optimization (PSO). *Proceedings - IEEE Region 10 Symposium, TENSymp*. Bali, Indonesia, 243-248.
16. Aboelela, M.A.S. (2019). Development of a fractional order PID controller for a physical system based on bat inspired algorithm. *8th International Conference on Modern Circuits and Systems Technologies*. Thessaloniki, Greece, 1-5.
17. Setiadi, H; and. Jones, K.O. (2016). Power system design using firefly algorithm for dynamic stability enhancement. *Indonesia Journal Electrical Engineering and Computer Science*, 1(3), 446-455.
18. Singh, K.S.M.J.; Elamvazuthi, I.; Shaari, K.Z.K; and Lima, F.V. (2016). PID tuning control strategy using cuckoo search algorithm for pressure plant. *6th International Conference on Intelligent and Advanced Systems*. Kuala Lumpur, Malaysia, 1-6.
19. Isermann, Rolf; and Munchhof, M. (2011). *Identification of dynamic system*. Germany: Springer Berlin Heidelberg.
20. Robandi, I. (2009). *Modern Power System Control*. Yogyakarta: Penerbit Andi.
21. Kumar, B.; Swain, S.K.; and Neogi, N.(2017). Controller design for closed loop speed control of BLDC motor. *International Journal on Electrical Engineering and Informatics*, 9(1), 146-160.
22. Jamaaluddin.; Robandi, I.; and Anshory, I.(2019). A very short-term load forecasting in time of peak loads using interval type-2 fuzzy inference system: A case study on java bali electrical system. *Journal of Engineering Science and Technology*, 14(1), 464-478.
23. Bambulkar, R.R.; Phadke, G.S.; and Salunkhe, S. (2016). Movement control of robot using fuzzy PID algorithm. *3rd International Conference on Electrical, Electronics, Engineering Trends, Communication, Optimization and Sciences*. Tadepalligudem, India, 1-5.
24. Live, H.J.; Wang, H.B.; Zhu, X.M.; Shen, Z.H.; and Chen, J.Y. (2017). Simulation research of fuzzy auto tuning PID controller based on MATLAB. *International Conference on Computer Technology, Electronics and Communication*. Dalian, China, 180-183.
25. Anshory, I.; Robandi, I.; and Wirawan. (2018). Parameters identification BLDC motor: instrumentations and transfer functions. *The 3rd Annual Applied Science and Engineering Conference*. Bandung, Indonesia, 1-4.
26. Jing J.; Wang, Y.; and Huang, Y. (2016). The fuzzy-PID control of brushless dc motor. *IEEE International Conference on Mechatronics and Automation*, Harbin, China, 1440-1444.
27. Raza, Y.; Ahmed, S.F.; Ali, A.; Joyo, M.K.; and Kadir, K.A. (2018). Optimization of PID using PSO for upper limb rehabilitation robot. *IEEE 5th International Conference on Engineering Technologies and Applied Sciences*. Bangkok, Thailand, 1-4.

28. Mukhtar, A.; Tayal, V.K.; and Singh, H. (2019). PSO optimized PID controller design for the process liquid level control. *3rd International Conference on Recent Developments in Control, Automation & Power Engineering*. Noida, India, 590-593.
29. Ali, M.; Nurohmah, H.; Budiman; Suharsono, J.; Suyono, H.; and Muslim, M.A.(2019). Optimization on PID and ANFIS controller on dual axis tracking for photovoltaic based on firefly algorithm. *International Conference on Electrical, Electronics and Information Engineering*. Bali, Indonesia, 1-5.
30. Sabir, M.M.; and Ali, T. (2016). Optimal PID controller design through swarm intelligence algorithms for sun tracking system. *Applied Mathematics and Computation*, 274, 690-699.
31. Sarangi, S.K.; Panda, R.; Priyadarshini, S.; and Sarangi, A. (2016). A new modified firefly algorithm for function optimization. *International Conference on Electrical, Electronics, and Optimization Techniques*. Chennai, India, 2944-2949.
32. Lastomo, D.; Widodo.; and Setiadi, H. (2018). Optimal power flow using fuzzy-firefly algorithm. *International Conference on Electrical Engineering, Computer Science and Informatics*. Malang, Indonesia, 210-215.

ORIGINALITY REPORT

---

10%

SIMILARITY INDEX

7%

INTERNET SOURCES

11%

PUBLICATIONS

5%

STUDENT PAPERS

---

PRIMARY SOURCES

---

- |   |   |    |
|---|---|----|
| 1 | Stephen Oladipo, Yanxia Sun, Zenghui Wang. "Optimization of PID Controller with Metaheuristic Algorithms for DC Motor Drives: Review", International Review of Electrical Engineering (IREE), 2020<br>Publication       | 1% |
| 2 | <a href="http://aperta.ulakbim.gov.tr">aperta.ulakbim.gov.tr</a><br>Internet Source   | 1% |
| 3 | Lecture Notes in Electrical Engineering, 2015.<br>Publication   | 1% |
| 4 | <a href="http://www.koreascience.kr">www.koreascience.kr</a><br>Internet Source   | 1% |
| 5 | <a href="http://www1.mengr.tamu.edu">www1.mengr.tamu.edu</a><br>Internet Source   | 1% |
| 6 | Dwi Lastomo, Widodo, Herlambang Setiadi. "Optimal Power Flow using Fuzzy-Firefly Algorithm", 2018 5th International Conference on Electrical Engineering, Computer Science and Informatics (EECSI), 2018<br>Publication | 1% |
-

7	<a href="http://www.researching.cn">www.researching.cn</a> Internet Source	1 %
8	Izza Anshory, Imam Robandi, Wirawan Wirawan. "Parameters identification BLDC motor: Instrumentations and transfer functions", MATEC Web of Conferences, 2018 Publication	1 %
9	<a href="http://www.mdpi.com">www.mdpi.com</a> Internet Source	1 %
10	Hu, Xiaoqing, Beibei Wang, Shengchun Yang, Taylor Short, and Lei Zhou. "A Closed-Loop Control Strategy for Air Conditioning Loads to Participate in Demand Response", Energies, 2015. Publication	1 %
11	Lai Chong Jin, Azrul Azim Abdullah Hashim, Salmiah Ahmad, Nor Maniha Abdul Ghani. "System Identification and Control of Automatic Car Pedal Pressing System", Journal of Intelligent Systems and Control, 2022 Publication	1 %
12	Submitted to Universidad Carlos III de Madrid Student Paper	1 %



Exclude quotes  On

Exclude bibliography  On

Exclude matches  < 1%